



US00D702308S

(12) **United States Design Patent**  
**Glock**

(10) **Patent No.:** **US D702,308 S**

(45) **Date of Patent:** **\*\* Apr. 8, 2014**

(54) **HANDGUN SLIDE WITH CUTOUTS AND  
INSERTS MOUNTED WITHIN THE CUTOUTS**

2011/0047847 A1\* 3/2011 Hughes et al. .... 42/1.01  
2013/0000173 A1\* 1/2013 Green et al. .... 42/70.11

\* cited by examiner

(76) Inventor: **Gaston Glock**, Velden am Woerthersee  
(AT)

*Primary Examiner* — Michael A Pratt

(\*\*) Term: **14 Years**

(74) *Attorney, Agent, or Firm* — Thomas | Horstemeyer,  
LLP

(21) Appl. No.: **29/426,638**

(57) **CLAIM**

(22) Filed: **Jul. 9, 2012**

The ornamental design of a handgun slide with cutouts and  
inserts mounted within the cutouts, as shown and described.

**DESCRIPTION**

(51) **LOC (10) Cl.** ..... **22-01**

FIG. 1 is a perspective view showing the top view, front view  
and left side view thereof;

(52) **U.S. Cl.**  
USPC ..... **D22/108**

FIG. 2 is a right side view thereof;

FIG. 3 is a left side view thereof;

(58) **Field of Classification Search**  
USPC ..... D22/104, 108; 124/72, 74; 89/40.06,  
89/41.19, 37.04, 33.04, 191.01, 200–204;  
42/40, 41, 42.01, 42.02, 42.03, 43, 44,  
42/45, 57, 69.01, 71.02, 72, 100  
See application file for complete search history.

FIG. 4 is a back view thereof;

FIG. 5 is a front view thereof;

FIG. 6 is a top view thereof; and,

FIG. 7 is a bottom view thereof.

Many aspects of the invention can be better understood with  
reference to the following drawings that include phantom  
lines, which do not form a portion of the claimed invention.  
For the drawings, the difference in stipple shading indicates a  
contrast of appearance and does not necessarily describe any  
color, texture, or material.

(56) **References Cited**

**U.S. PATENT DOCUMENTS**

8,387,294 B2\* 3/2013 Bolden ..... 42/1.01

**1 Claim, 5 Drawing Sheets**

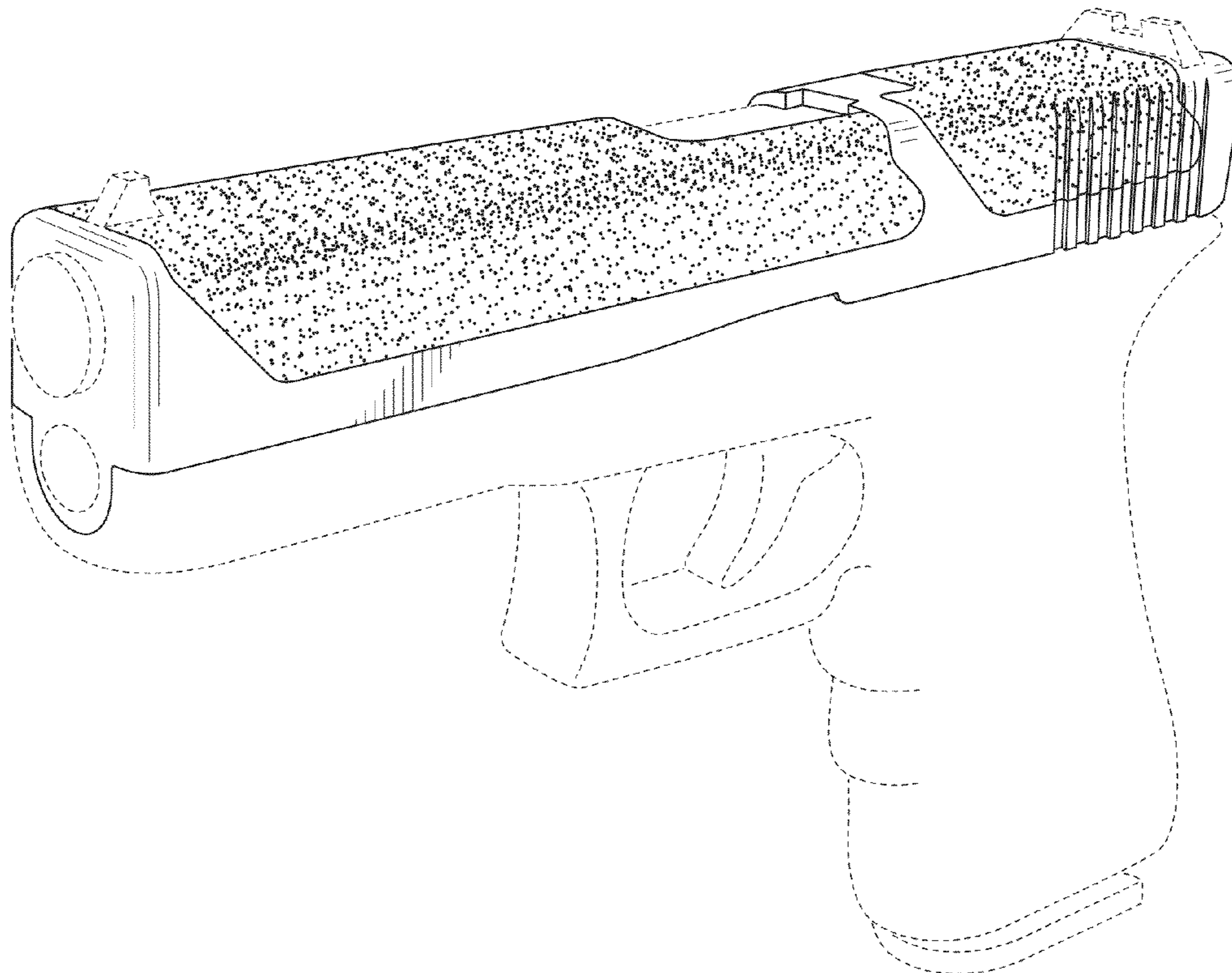

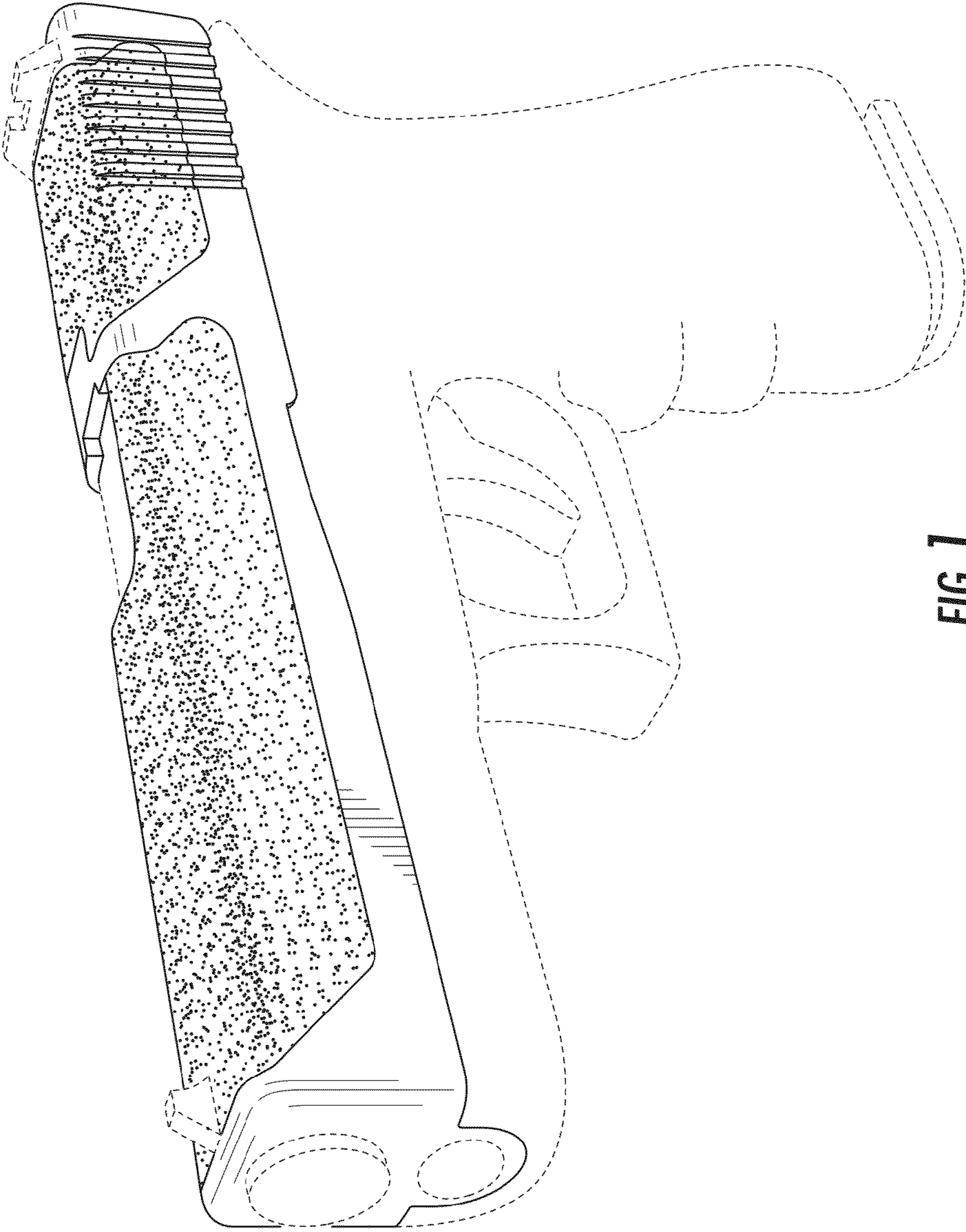

FIG. 1

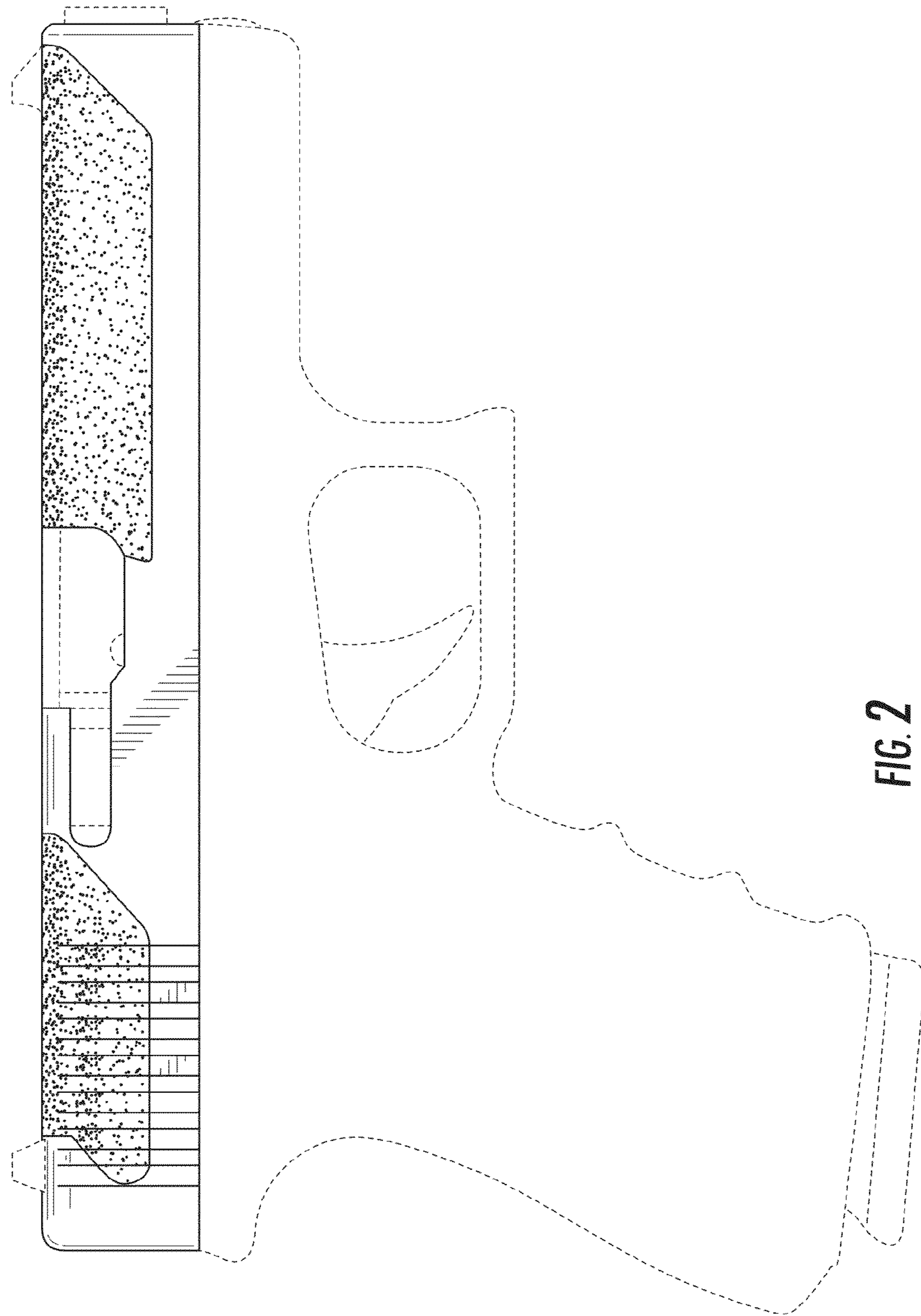

FIG. 2

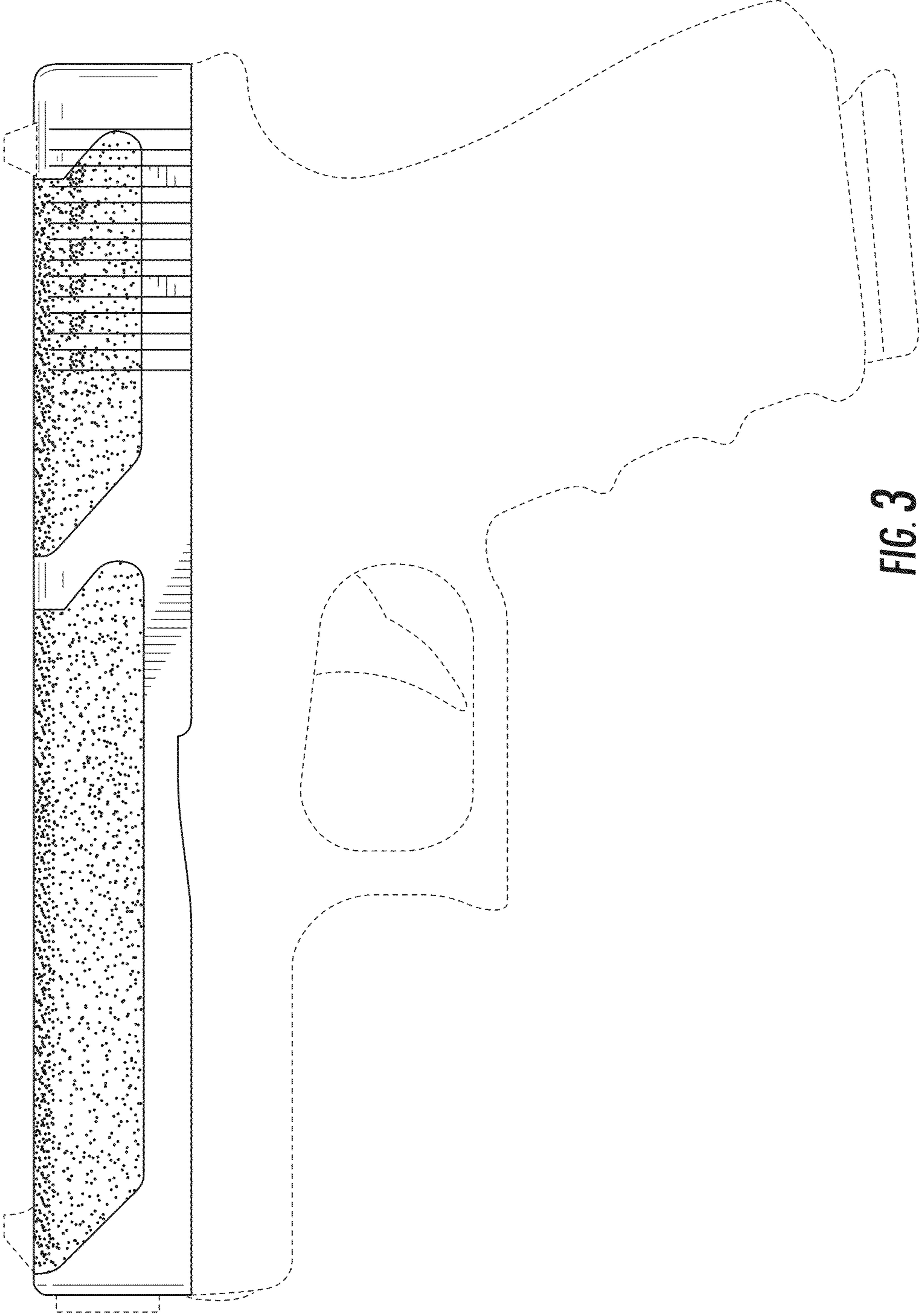
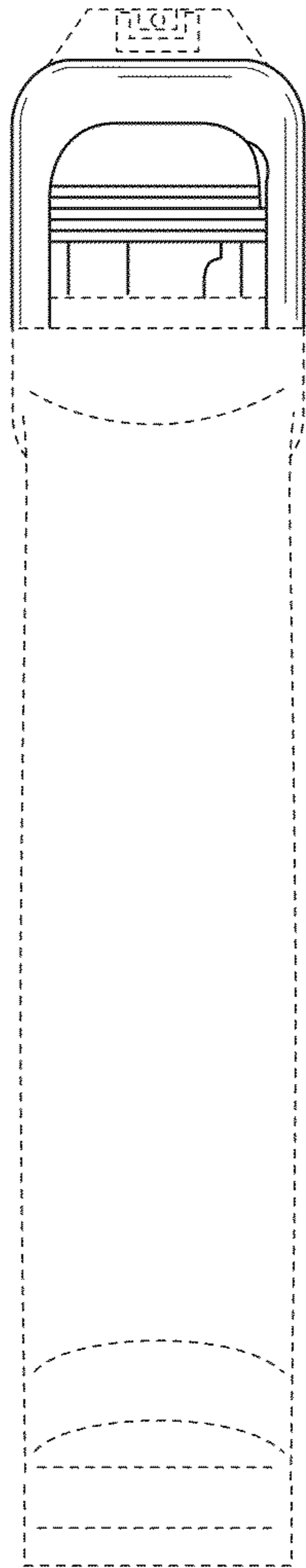
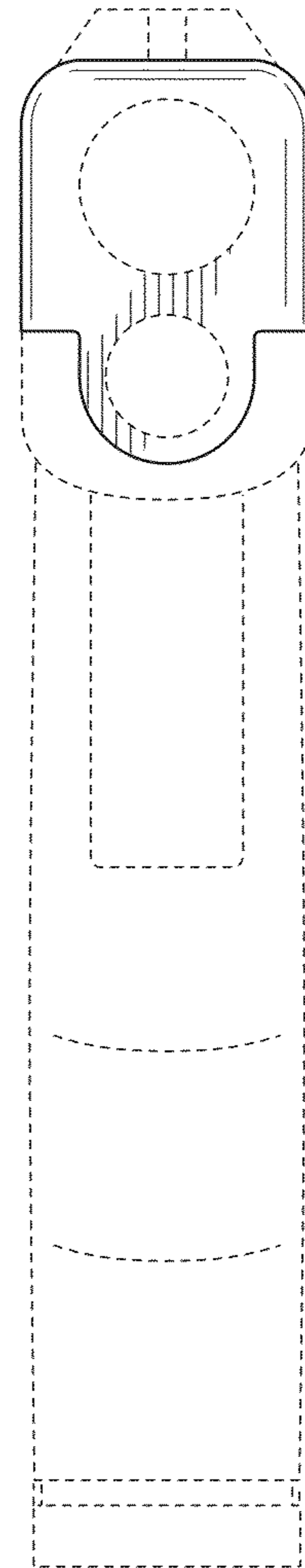

FIG. 3

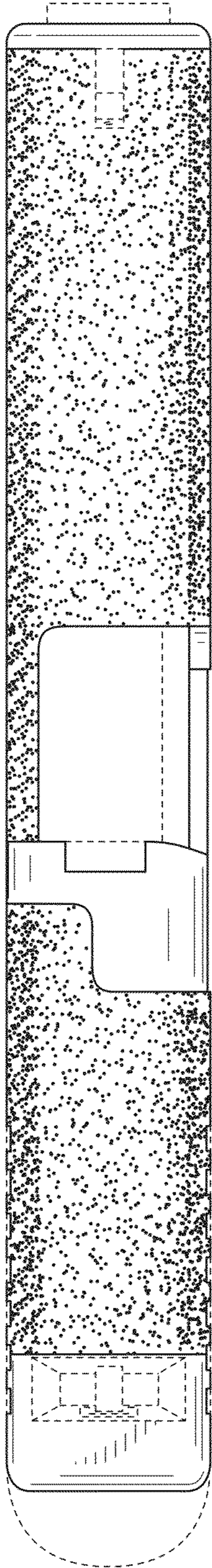



**FIG. 4**



**FIG. 5**



*FIG. 6*

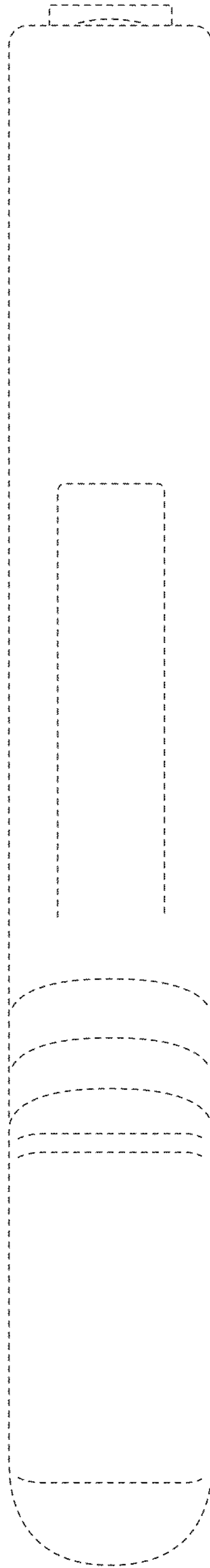

*FIG. 7*